

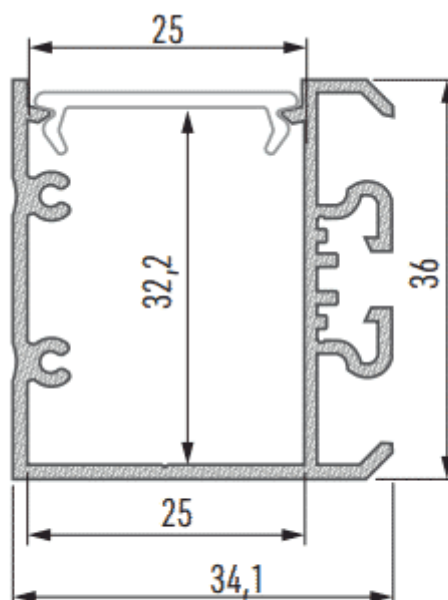

## PR5013-GRIS

Profilé luminaire

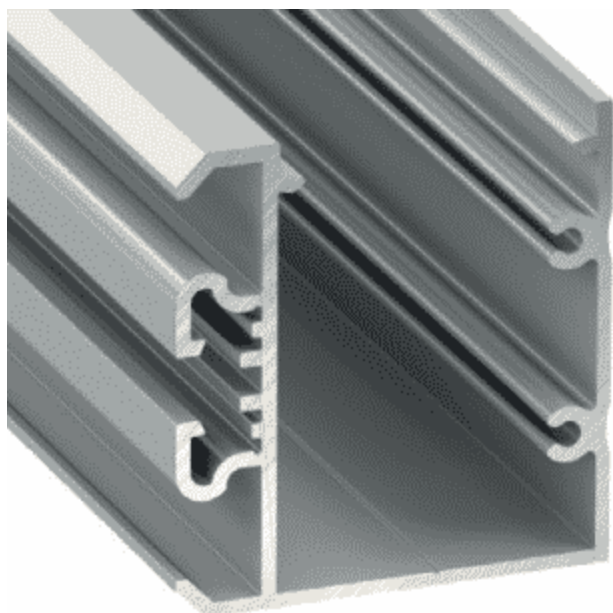

## Caractéristiques techniques

LARGEUR	34,1mm
LARGEUR INTÉRIEURE	25,0mm
HAUTEUR	36,0mm
MATIÈRE	Aluminium
CONDITIONNEMENT	1 pièce



## Références

NOM COMMERCIAL RÉF. CONSTRUCTEUR	LONGUEUR	COULEUR DU PRODUIT
<b>PR5013-2MGRIS</b> ENG0300400000013	2,0m	Gris
<b>PR5013-3MGRIS</b> ENG0300400000021	3,0m	Gris
<b>PR5013-GRIS-SP</b> ENG0310400000012	Sur-mesure	Gris

## Accessoires associés non inclus

NOM COMMERCIAL RÉF. CONSTRUCTEUR	DESCRIPTION	COULEUR	MATIERE	ILLUSTRATION
<b>PR5013-1GRIS</b> ENG0309901000200	PR5013 BOUCHON DE FINITION GRIS VENDU PAR 2	Gris	Plastique	