

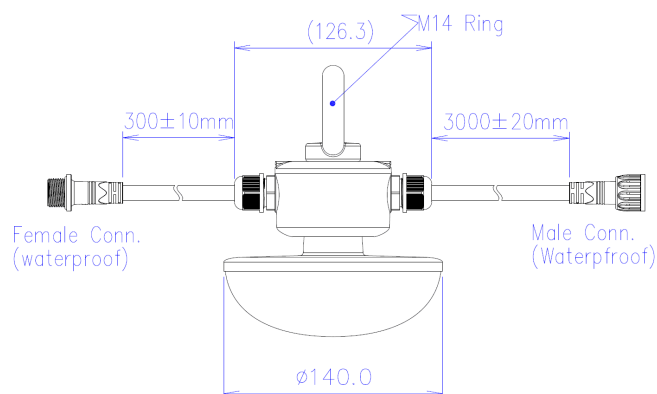

LA1011-T 230VAC 15W

Luminaire agricole



Caractéristiques techniques

DIAMÈTRE	140,0mm
MATIÈRE	Polycarbonate
POIDS	630,0g
TENSION D'ALIMENTATION	200-240Vac
PUISSANCE MAXIMALE	15,0W
CONDITIONNEMENT	1 pièce



Références

NOM COMMERCIAL RÉF. CONSTRUCTEUR	TEINTE	FLUX	EFFICACITÉ LUMINEUSE
LA1011-T-230-15BL27 ENG0810300000034	2700°K	1650lm	120lm/W
LA1011-T-230-15BL40 ENG0810300000035	4000°K	1650lm	120lm/W