

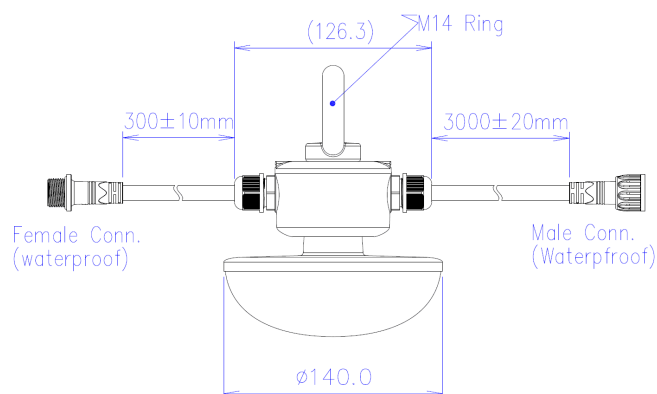

## LA1011-T 230VAC 9W

Luminaire agricole



### Caractéristiques techniques

DIAMÈTRE	140,0mm
MATIÈRE	Polycarbonate
POIDS	630,0g
TENSION D'ALIMENTATION	200-240Vac
PUISSANCE MAXIMALE	9,0W
CONDITIONNEMENT	1



## Références

NOM COMMERCIAL RÉF. CONSTRUCTEUR	TEINTE	FLUX	EFFICACITÉ LUMINEUSE
<b>LA1011-T-230-9BL27</b> ENG0810300000030	2700°K	1080lm	120lm/W
<b>LA1011-T-230-9BL40</b> ENG0810300000031	4000°K	1080lm	120lm/W